



*THE **SEARA***  
*PENDENT-CEILING-POST*



**GLL450 SERIES**

THE **SEARA**  
PENDENT-CEILING-POST

	40W 60W 80W 115W	<b>SEARA PENDANT</b>
	40W 60W 80W 115W	<b>SEARA CEILING</b>
	40W 60W 80W 115W	<b>SEARA POST</b>

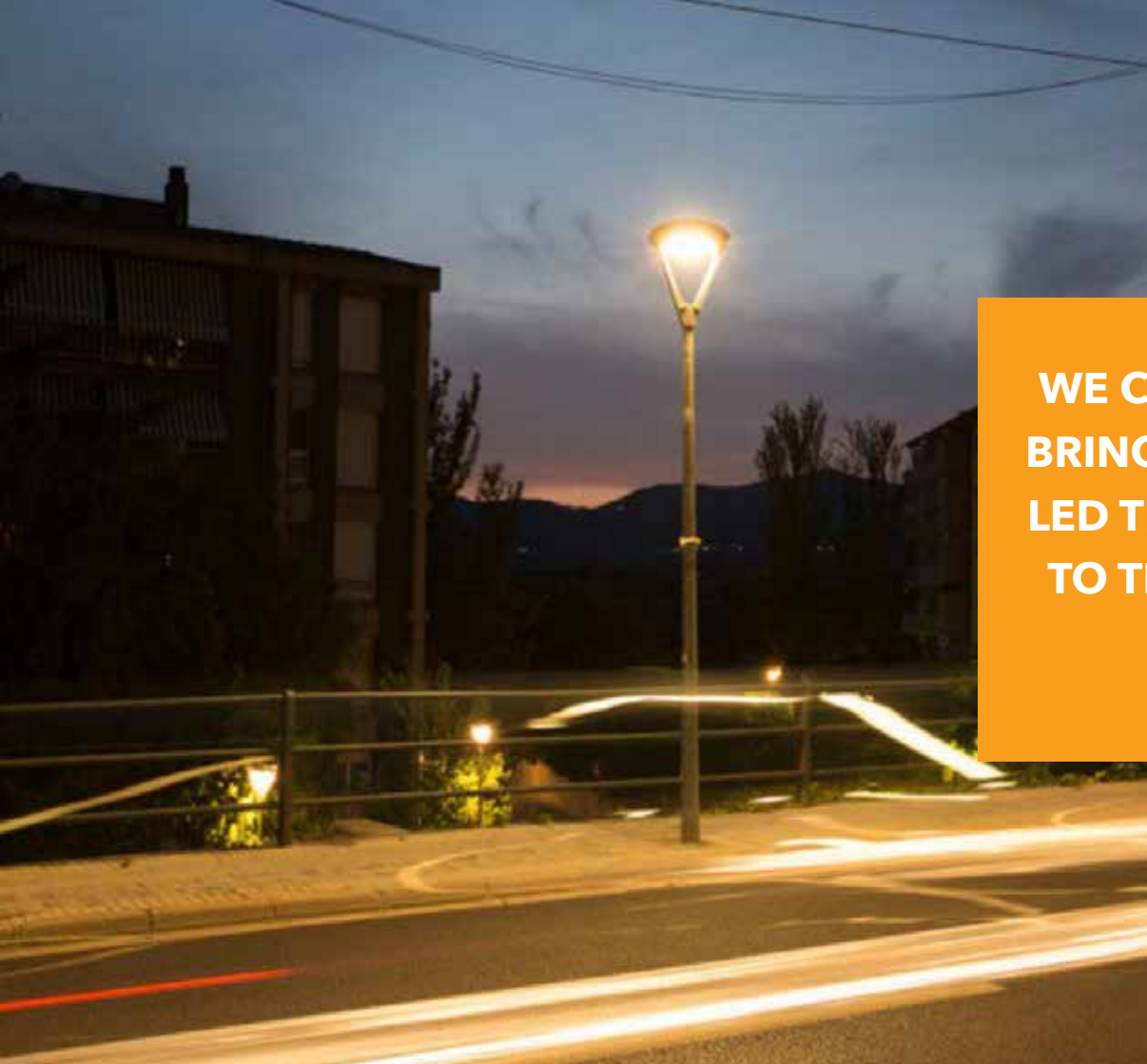

**WE CONTINUE TO  
BRING ADVANCED  
LED TECHNOLOGY  
TO THE LIGHTING  
INDUSTRY.**

# THE SEARA

## PRODUCT OVERVIEW

---

The Seara is a Versatile LED Fixture that is made from a die-cast grade of aluminum. with tempered borosilicate glass lens or a vandal resistant polycarbonate.

The Seara also utilizes stainless steel hardware for it's components. Offering multiple mounts, the Seara includes various types of optics for it's appropriate useage. The optics available are Type III, Type IV, Type V-A and Type V-B.



### KEY FEATURES

- Premium brand LEDs (Citizen® or CREE® COB chips depending on SKU) and YG® driver technology
- Dimming option available
- Surface, pendant, post-top mounts available
- Precision die cast
- IP66 rated fixture for outdoor use
- Chip and fade resistant powder coat finish in a ny color
- Prismatic Retractor
- Industrial grade
- Easy installation surface mount
- Architectural design with excellent performance
- Forward throw reflector
- Industrial grade, Button-type photocell



**GLL 450 (Pendant)**

40W  
60W  
80W  
115W



**GLL 450 (Ceiling)**

40W  
60W  
80W  
115W



**GLL 450 (Post)**

40W  
60W  
80W  
115W

## CERTIFICATIONS

- DLC 4.2 Standard
- cUL-us Listed

## SPECIFICATION & VARIATIONS

Sample

GLL450-60W-40K-V8-D-PC-5A-S1-BZ-PT

BODY TYPE	SYSTEM WATTAGE	CCT	VOLTAGE	DIMMING OPTION	ELECTRICAL (PHOTOCELL)	ELECTRICAL OPTICS	SURGE PROTECTOR	HOUSING FINISH	MOUNTING
GLL 450 -	60W -	40K -	V8 -	D -	PC -	T3 -	S1 -	BZ -	PT -
GLL 450	40W 60W 80W 115W	30K = 3000K 40K = 4000K 50K = 5000K	V1 = 120V V2 = 208V V3 = 220V V4 = 240V V5 = 277V V7 = 480V V8 = 120-277V	D = Dimming N = Non-Dimming	PC = Photocell NA = None	T3 = TYPE III T4 = TYPE IV 5A = TYPE V-A 5B = TYPE V-B	S1 = Surge Protector NA = None	BZ = Bronze WH = White BK = Black SL = Silver GY = Gray	PT = Post PM = Pendant CM = Ceiling

**BUILD YOUR ORDER SKU NUMBER** - If you don't see a specific feature listed above, please contact your regional sales representative for details about custom made to order (MTO) luminaires.

## PRODUCT SUMMARY

LED Chip:	Premium brand LEDs: Citizen® or CREE® COB chips
CRI:	≥70
THD:	< 20% @ full load
PF:	> 0.9 @ full load, 100V through 277V
Driver Efficiency:	> 85%
Warranty:	Warranty: 5 Years (terms and conditions apply).
Ambient Operating Range:	-30°C to 40°C
Rated Life:	More than 50K hours per L70 TM-21 @ 70 °C
Dimensions:	Pendant: 15.75" X 4.87", Ceiling: 15.75" X 5.45", Post: 15.75" X 19.00"
Weight:	14.33 lbs
Electrical:	120-277V operation, 50/60Hz, Single Driver RoHS and IP65
Application:	Ideal for Garage, Residential

# THE SEARA

PRODUCT SPECIFICATIONS



## SEARA 450 CEILING

CCT	SYSTEM WATTAGE	LED WATTAGE	LUMENS (LMS)	LUMENS PER WATT	REPLACES (MH)	CRI	OPTICS INFORMATION	VOLTAGE	WEIGHT
40K	40W	36W	4040	101	150W	≥70	TYPE V-A	120-277	14.33 lbs
	60W	54W	6360	106	200W				
	80W	70W	8880	111	250W				
	115W	102W	12765	111	400W				
50K	40W	36W	4000	100	150W	≥70	TYPE V-A	120-277	14.33 lbs
	60W	54W	6300	105	200W				
	80W	70W	8800	110	250W				
	115W	102W	12650	110	400W				

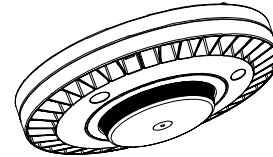
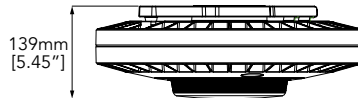
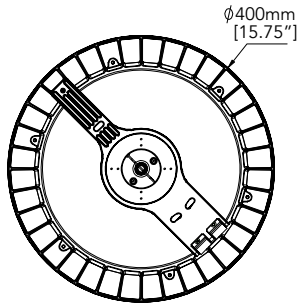

# THE SEARA

## PRODUCT SPECIFICATIONS

### SEARA 450 PENDANT

CCT	SYSTEM WATTAGE	LED WATTAGE	LUMENS (LMS)	LUMENS PER WATT	REPLACES (MH)	CRI	OPTICS INFORMATION	VOLTAGE	WEIGHT
40K	40W	36W	4640	116	150W	≥70	TYPE V-B	120-277	14.33 lbs
	60W	54W	7260	121	200W				
	80W	70W	10080	126	250W				
	115W	102W	14490	126	400W				
50K	40W	36W	4600	115	150W	≥70	TYPE V-B	120-277	14.33 lbs
	60W	54W	7200	120	200W				
	80W	70W	10000	125	250W				
	115W	102W	14375	125	400W				

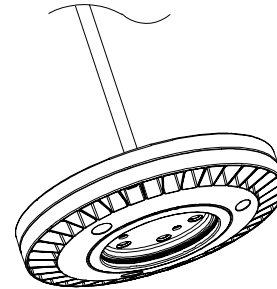
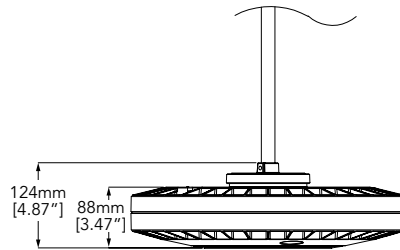
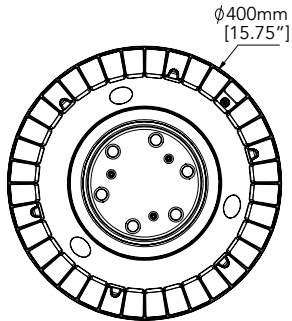



# THE SEARA

## PRODUCT SPECIFICATIONS



### SEARA 450 POST

CCT	SYSTEM WATTAGE	LED WATTAGE	LUMENS (LMS)	LUMENS PER WATT	REPLACES (MH)	CRI	OPTICS INFORMATION	VOLTAGE	WEIGHT				
40K	40W	36W	4087	102	150W	≥70	TYPE III	120-277	14.33 lbs				
			4240	106			TYPE V-A						
	60W	54W	6192	103	250W		TYPE V-B						
			6540	109			TYPE III						
	80W	70W	8080	101	250W		TYPE V-A						
			8129	100			TYPE V-B						
			9120	114			TYPE III						
	115W	102W	11615	101	400W		TYPE V-A						
			13110	114			TYPE V-B						
							TYPE III						
	40K	40W	36W	4054	101		150W			≥70	TYPE III	120-277	14.33 lbs
				4140	104						TYPE V-A		
60W		54W	6120	102	250W	TYPE V-B							
			6480	108		TYPE III							
80W		70W	8000	100	250W	TYPE V-A							
			8297	101		TYPE V-B							
			9000	113		TYPE III							
115W		102W	11500	100	400W	TYPE V-A							
			12938	113		TYPE V-B							
						TYPE III							

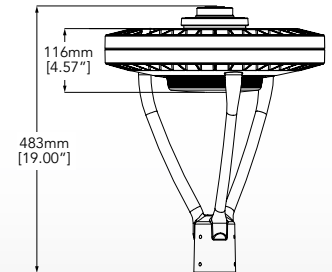
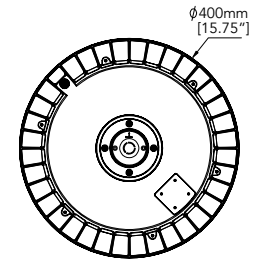

## Ready to Order or have any questions?

Contact us for any additional information, such as IES documentation and lighting specification Sheets, or please visit us online at: [www.eranindustrial.com](http://www.eranindustrial.com)

 **Office**  
1.844.411.LITE

 **Sales**  
[sales@eranindustrial.com](mailto:sales@eranindustrial.com)

### Office Location.



**USA Office**  
3500 NW 2nd Avenue,  
Ste 717 Boca Raton,  
Florida 33431



**CHINA Headquarters**  
17/F Guangbo Mansion  
#1357 Yinxian Avenue  
Yinzhou District  
Ningbo, China 315100





**eran** industrial.